



www.gillathletics.com
800-637-3090

80401 - PRO-DOWN DISCUS CAGE W/SLEEVES SPECIFICATIONS

SPECIFICATIONS

The 80401 High School Pro-Down Discus Cage consists of six galvanized steel upright poles with ground sleeves, five galvanized steel top rungs to eliminate net sag, and a weather treated nylon net. The poles are 12 gauge, 2³/₈" O.D. steel tube swaged at the top to receive the top rungs. Each pole stands in a 24" deep ground sleeve. The top rungs are formed from 1" O.D. 16 gage steel tube and form a solid frame to support the net. The 12' x 63' net is supported by 32 net hooks permanently attached to the top of the net. The nylon net has breaking strength of 180 lbs and has been weather treated for longer life.

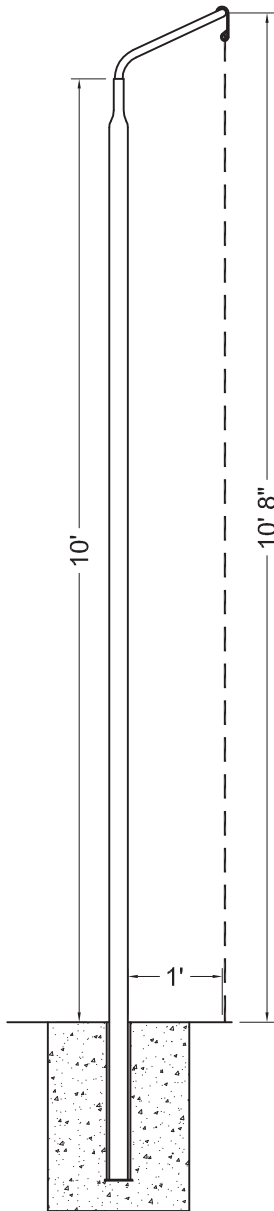

Net Pole Plan View

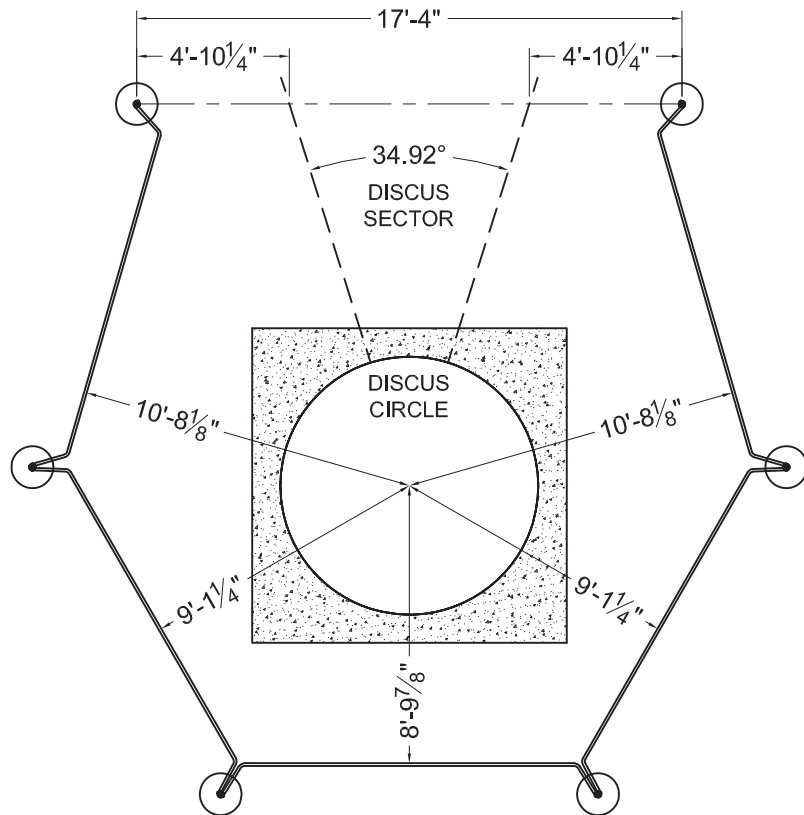

DIAGRAM "A" - Cage Layout

NOTICE: All installations should be conducted by experienced contractors and in accord with all applicable codes, laws and regulations. Suggested instructions herein are illustrative only and should be adapted to suit local requirements. Gill Athletics is not responsible for the manner in which these products are installed.



www.gillathletics.com
800-637-3090

80401 - PRO-DOWN DISCUS CAGE W/SLEEVES INSTALLATION

INSTRUCTIONS FOR GROUND SLEEVES

1. Measure straight back along the sector center line 9'-9 $\frac{3}{4}$ " from the circle center and mark. Measure out 6' perpendicular to the sector center line from this mark in both directions for the center point of the back two Ground Sleeves. Mark and cross check these two points. They should be 11'-6" from the circle center (refer to Diagram B).
2. Mark the center point for the middle two Ground Sleeves. These two points are 12' from the rear sleeve centers and the circle center (refer to Diagram B).
3. Mark the center point for the front two Ground Sleeves. These two points are 12' from the middle sleeve centers and 14'-11" from the circle center (refer to Diagram B).
4. Place stakes with crossed strings to mark the Ground Sleeve centers at each sleeve position. Remove the strings and dig six 27" deep holes at marked locations. The minimum recommended diameter for these holes is 16". Soil conditions at your sight may require larger diameter concrete bases for each pole.
5. Place approximately 4 $\frac{1}{2}$ " of compacted rock in the bottom of each hole. The rock should support the Ground Sleeve at the proper height and allow water in the sleeve to drain away.
6. Replace the strings marking the hole centers. Check center dimensions to verify stakes were not moved when the holes were dug. Tape the bottom end of each Ground Sleeve closed with duct tape to prevent concrete from coming up inside the sleeve. Set each Ground Sleeve in place so the top edge is $\frac{1}{2}$ " above ground level. Position the Ground Sleeves so the sleeve centers are directly under the crossed strings. As the Ground Sleeves must remain vertical, secure them in place with wire and short sections of rebar.
7. Carefully pour concrete around the Ground Sleeves. Check with a level to ensure sleeves have remained vertical. The concrete should slope away from the top edges of the Ground Sleeves to ground level to help keep water and debris out of the sleeves.

Ground Sleeve Caps are available, but sold separately.
Works with Ground Sleeve Cap #8040146

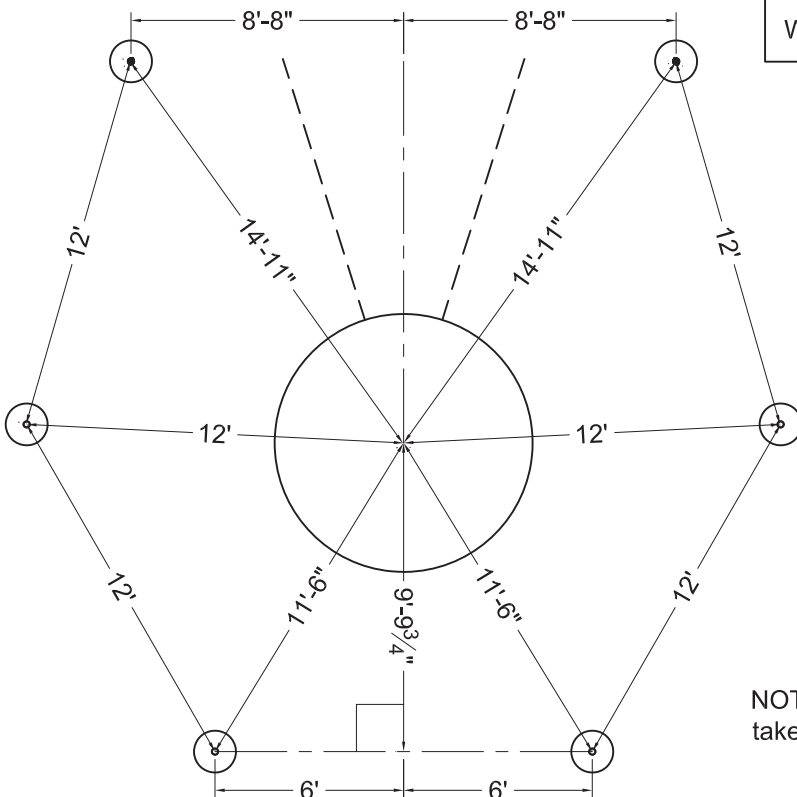
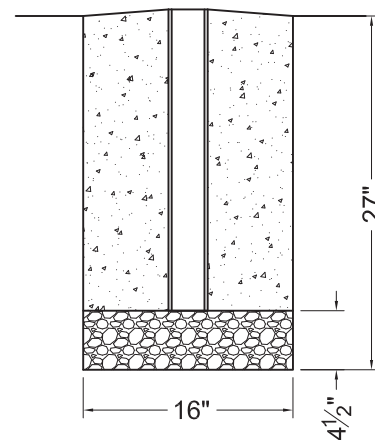

DIAGRAM "B" - Sleeve Placement



NOTE: All measurements are taken from Ground Sleeve centers.



www.gillathletics.com
800-637-3090

80401 - PRO-DOWN DISCUS CAGE W/SLEEVES INSTALLATION

FRAME ASSEMBLY INSTRUCTIONS

1. Place one Upright Pole in each of the Ground Sleeves. Starting at the back of the cage, install a Top Rung into the sockets at the top of the pole. The Top Rungs slope inward toward the center of the circle. It will be easier if two people with ladders install each end of the Top Rungs at the same time.

2. Install the remaining Top Rungs working toward the front of the cage. It may be necessary to rotate the position of the Upright Pole sockets to ease installation.

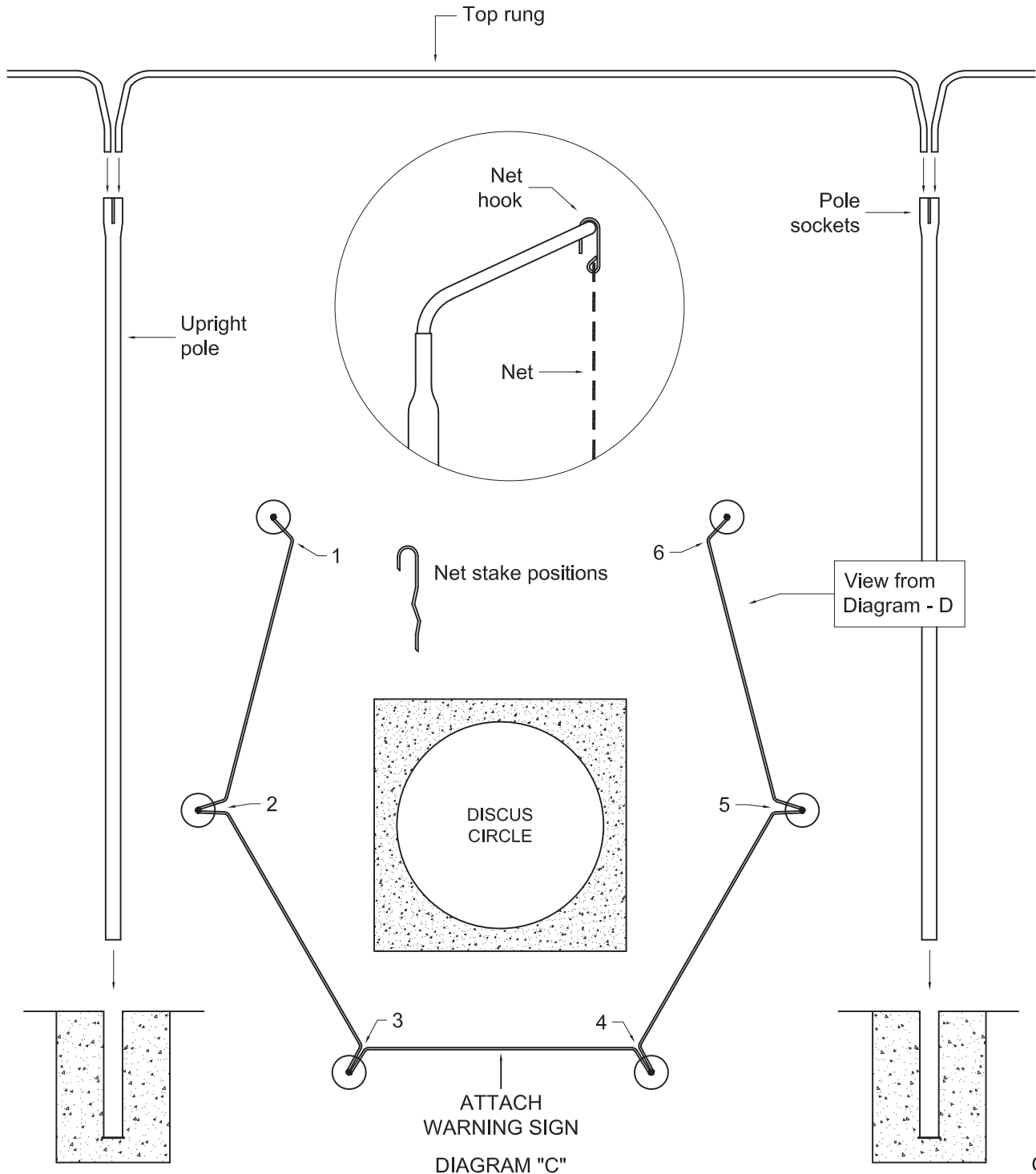



www.gillathletics.com
800-637-3090

80401 - PRO-DOWN DISCUS CAGE W/SLEEVES INSTALLATION

NET HANGING INSTRUCTIONS

1. Lay the Net out inside the cage and attach the small loop side of the Net Hooks to the top rope binding in 24" intervals starting in the right corner and working your way along the entire net. Using a ladder, place the first corner Net Hook in the open end atop the right front Upright Pole. Place the next Net Hook on the Top Rung and continue hanging Net Hooks on the Top Rungs around the cage frame. The last Net Hook is placed in the open end atop the left front Upright Pole. Adjustment of the net hook locations may be needed after the net is hung.

2. After net has been hung evenly, secure the sides of the Net to the two front Upright Poles with the 15' Ropes. Tie the Rope into the top corner square of the Net with the net hook, and lace the Rope downward, around the pole and tie at the bottom. Secure the base of the Net with the six Net Stakes at the positions shown in Diagram C. Attach Warning sign to the Net at the back of the cage for the spectators to see.

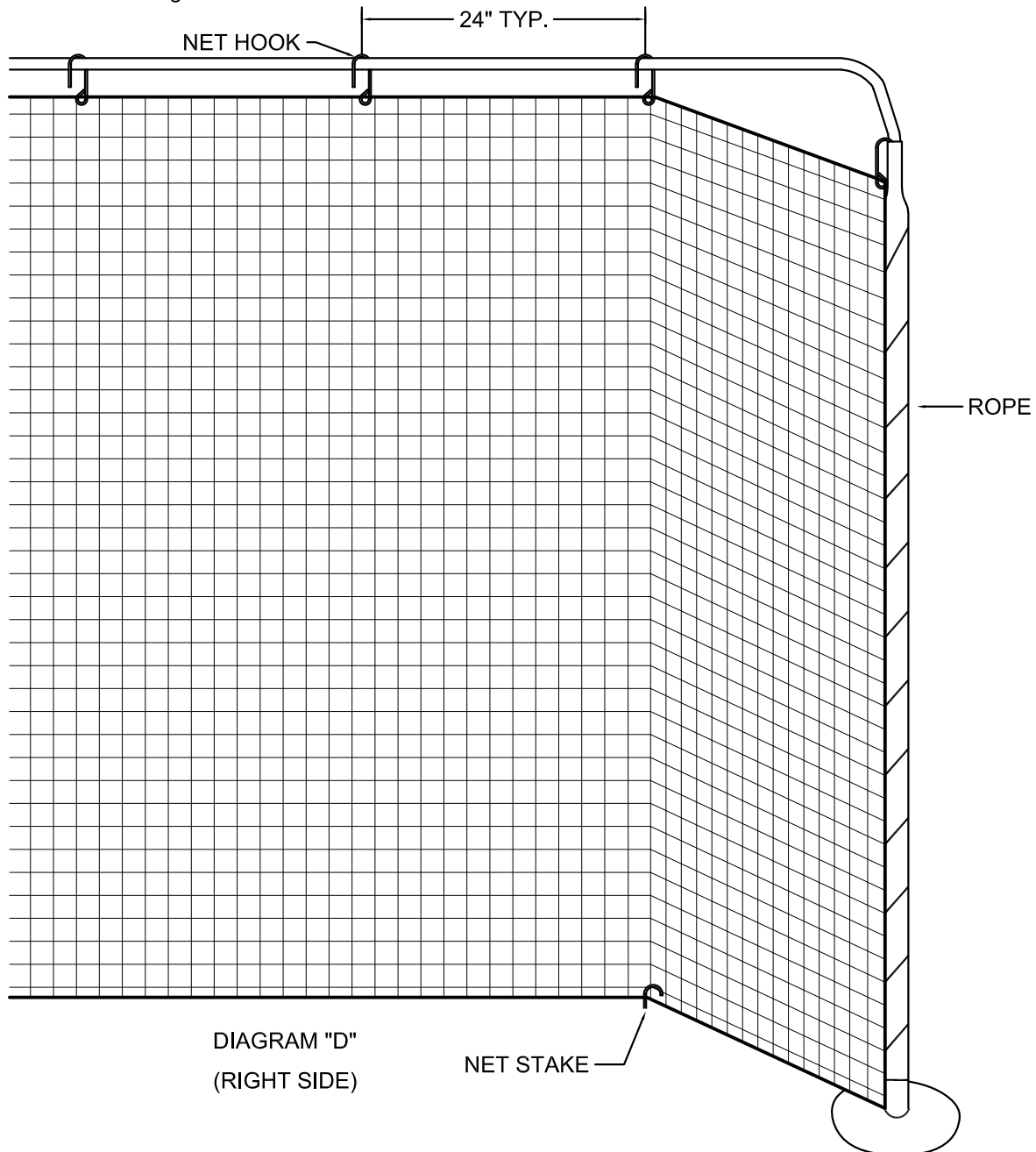

WARNING : Cancer and Reproductive Harm –
For more information go to www.p65warnings.ca.gov

suggestions@gillathletics.com
Copyright ©2022 by Gill Athletics. All rights reserved.

GILL ATH
03/03/22
80401-4



www.gillathletics.com
800-637-3090

THROWING CAGE INSTALLATION OF WARNING SIGNS

For the protection of athletes, spectators, and coaches install warning signs according to the diagram below.

Attach signs (M2322) to the cage net with the included 1.25" rings (M1250) in each corner. Signs should face away from the cage toward spectators.



Center Back: Attach sign to the outside of the net at eye level in the middle of the back of the cage.

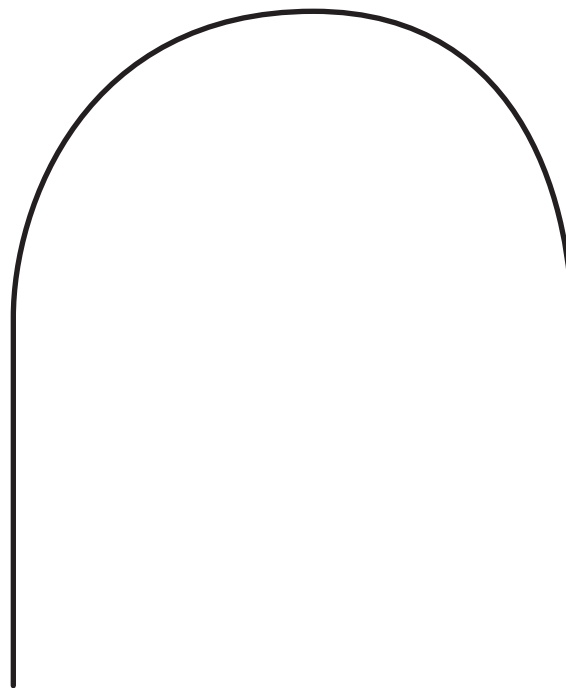

Left Front Side: Attach sign to the outside of the net at eye level near the front left side of the cage.



Right Front Side: Attach sign to the outside of the net at eye level near the front right side of the cage.





www.gillathletics.com
800-637-3090

80401 - PRO-DOWN DISCUS CAGE with SLEEVES SHIPPING LIST

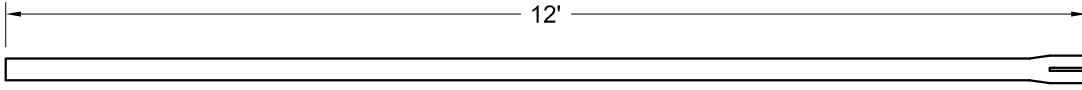

UPRIGHT POLE
8040120 x 6

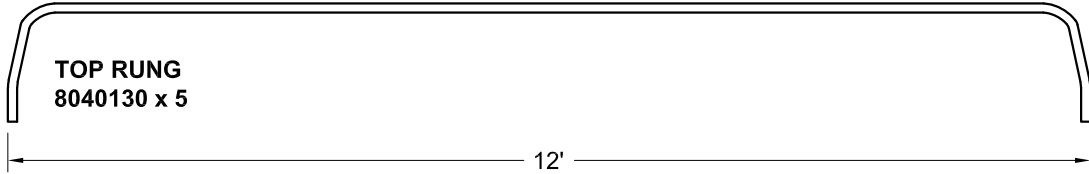

TOP RUNG
8040130 x 5

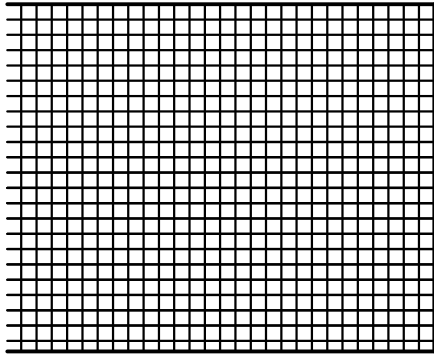

NET
M2003 x 1

CAGE COMPONENTS 8040140 x 1

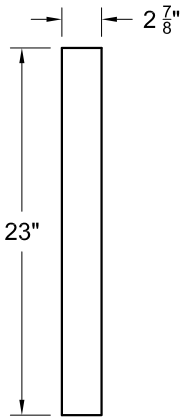

GROUND SLEEVE
8040145 x 6



NET STAKE
ANCR000400E0x 6

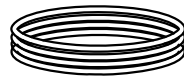

**1/4 ROPE POLYESTER
BRAIDED CORD**
M2005
15' x 2



NET HOOK
M1253x 32



LOOSE LEAF RING
M1250 x 12

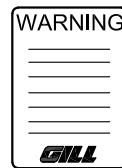

WARNING SIGN
M2322 x 3

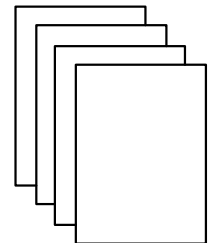

INSTRUCTIONS
1 SET REQUIRED